

# DAGENHAM MOTORS LTD.

56 PARK LANE  
LONDON, W.1  
REGENT 4866



*DISTRIBUTORS  
FOR*

MIDDLESEX BEDFORDSHIRE  
HERTFORDSHIRE & ESSEX

*SERVICE*

8 BALDERTON STREET W.1.  
(OPPOSITE SELFRIDGES)  
REGENT 4070

374 EALING ROAD ALPERTON  
WEMBLEY MIDDLESEX

PERIVALE 3388

# ALLARD

# *Official* YEAR BOOK 1951-52



# WILMOT BREEDEN

LIMITED

*Britain's leading manufacturers of automobile  
components and accessories*



**BUMPERS AND OVER-RIDERS**

**DOOR HANDLES AND LOCKS**

**WINDOW WINDERS**

**STEERING WHEELS**

**ROOF LAMPS & SWITCHES**

**RADIATOR & HORN GRILLES**

**ASH TRAYS**

**BONNET HINGES**

**BODY MOULDINGS**

**BADGES AND MASCOTS**

**LOCKING PETROL CAPS**

**IGNITION LOCKS**

**HYDRAULIC-ELECTRIC**

**EQUIPMENT**

# WILMOT BREEDEN

LIMITED

**BIRMINGHAM:** Amington Road, Birmingham, 25

**GLASGOW:** 57 Miller Street, Glasgow, C.1

**MANCHESTER:** 64/66 Upper Brook Street, Manchester, 13

**LONDON:** Sunbeam Road, Chase Road, London, N.W.10

**BRISTOL:** 75 Queen's Road, Bristol, 8

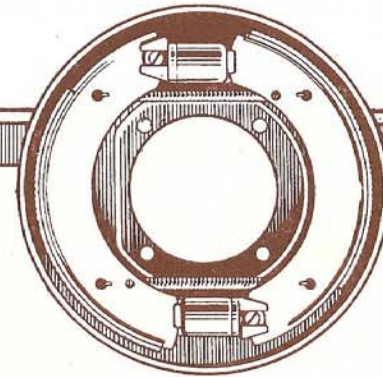

**BRITAIN'S  
FASTEST  
PRODUCTION CARS**

CHOOSE

# Lockheed

REGO TRADE MARK

TWO-LEADING-SHOE

**HYDRAULIC  
BRAKES**

**for safety and reliability**

AUTOMOTIVE PRODUCTS COMPANY LTD.

LEAMINGTON SPA, ENGLAND

*ALLARD choose*

# CORRUJOINT

THE ORIGINAL ALL-METAL

# GASKETS

*for their higher efficiency  
and greater reliability!*

The Cylinder Head Joint  
that WILL NOT BLOW !!

*Sole Manufacturers:*

**THE CORRUGATED PACKING &  
SHEET METAL CO. LTD.**

Tel. No. 71785

**GATESHEAD-ON-TYNE**

# A. E. HARRIS LTD.

of **CARDIFF** ●

MAIN



**DISTRIBUTORS**

FOR THE COUNTIES OF  
GLAMORGAN, MONMOUTH, BRECKNOCK  
CARMARTHEN, RADNOR, CARDIGAN  
AND PEMBROKE

Phones : 3749 - 3750 - 8392

● **SALES:**  
10/11 CASTLE STREET  
FACILITIES & SPARES :  
WEST WHARF ROAD

**CARDIFF**

**THE LUNKEN COMPANY LTD**

299 Gander Green Lane, Cheam, Surrey

Manufacturers of  
"Sureflex" Petrol and Oil Pipes  
as fitted by The Allard Motor Co. Ltd.

INTRODUCE

**THE  
B • M • S  
Car Immobiliser**

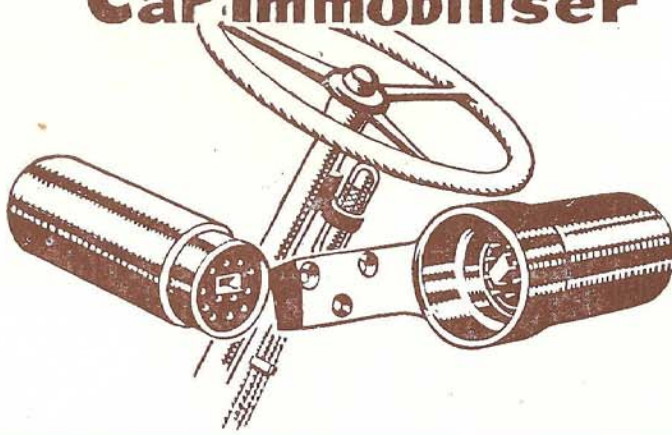

A DEVICE THAT FOILS THE EXPERT CAR THIEF

OVER 1,000,000 COMBINATIONS

NO MAINTENANCE COSTS

FITTING TIME 30 MINUTES APPROX.

PRICE **75/-** COMPLETE  
SPARE CAP 25/-

LUNKEN . SUTTON . SURREY

DERWENT 7777/8/9

**THE FOUR NORTHERN COUNTIES**

Cumberland

Durham

Northumberland

Westmorland

MAIN



DEALERS

We Specialise in

**"SERVICE"**

**R.H. Patterson**  
AND CO. LTD

FORTH STREET

NEWCASTLE-ON-TYNE, 1

**Reliable  
Suspension at  
High Speed...**

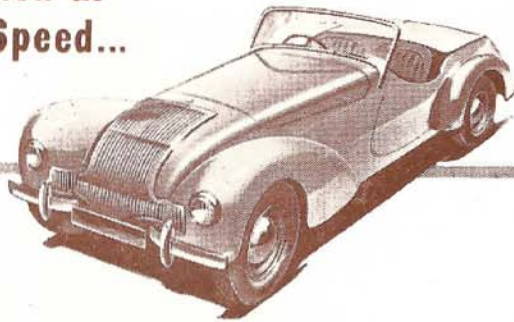

The road-holding and cornering abilities of the Allard are legion wherever fast motorcars are discussed. To achieve such outstanding performance the Allard Motor Co. fit Woodhead Springs controlled by Woodhead-Munroe Shock Absorbers to all their models, thus ensuring the highest degree of efficiency and reliability under extremely exacting conditions. Illustrated are both front and rear suspensions—inside information on the equipment which plays such an important part in the performance of this fine car.

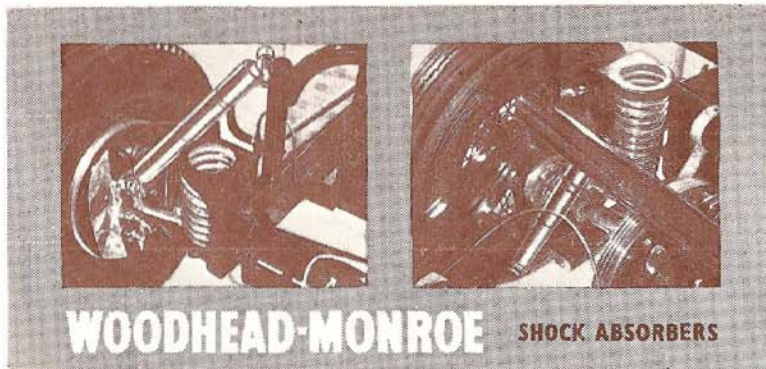

JONAS WOODHEAD & SONS LTD · KIRKSTALL ROAD · LEEDS 4



---

**DISTRIBUTORS  
FOR  
LANCASHIRE  
AND  
CHESHIRE**

**SALES  
AND  
SERVICE**

**H. E. NUNN & CO. LTD.**

282 BURY NEW ROAD  
MANCHESTER · 7

Telephone : BRoughton 2201

# ADLARDS MOTORS LTD.

**ALLARD**  
SALES  
SPARES  
SERVICE

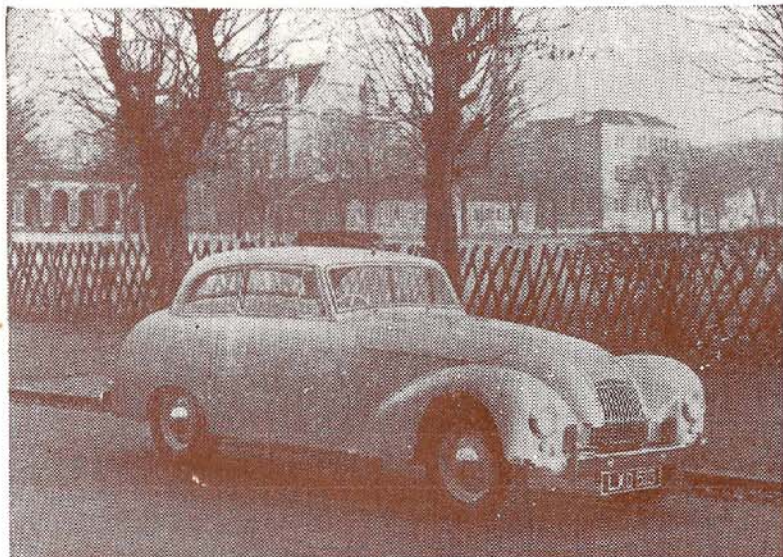

Distributors for South London, Surrey, Sussex and Kent  
Full Stock of Allard Spares and Accessories for all models  
Facilities for the Complete Servicing of Allard cars

**43 ACRE LANE  
BRIXTON  
S.W.2.**

Brixton 6431

# THE ALLARD MOTOR COMPANY LIMITED

24/28 CLAPHAM HIGH STREET, S.W.4  
TELEPHONE :: MACAULAY 3201

## *Official Year Book* *1951-52*

PUBLISHED BY  
TOWN & COUNTRY PUBLICATIONS  
(STAPLES & HANCOCK LTD.)  
1-3 ADDISCOMBE ROAD, CROYDON

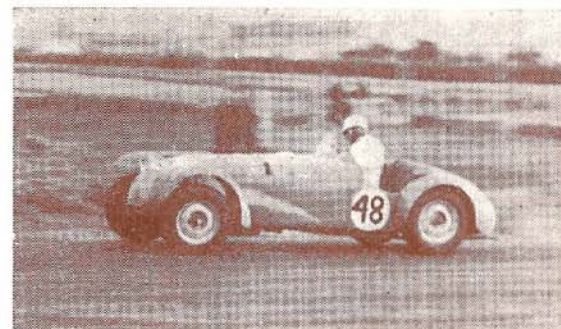

## *A History, in brief . . . .*

The first ALLARD SPECIAL was built by Sydney Allard in 1936, to be followed by a succession of 'one off' competition cars, each of which was soon busy collecting trophies in home trials.

The outstanding success of these specials led to the decision to commence production of more-or-less standard models and in 1946 the ALLARD MOTOR COMPANY LTD., was formed. The first model produced by the Company was a sleek 2-seater Sports with 30 h.p. V.8 engine and these soon proved their worth by finishing first of 173 competitors in the Lisbon Rally in 1947 and winning premier awards in the Alpine Trial, Maloja Hill Climb, Develiers des Rancieres, Craiganlet Hill Climb and Bouley Bay Hill Climb, as well as winning hosts of less important events.

In 1948, slight modifications were made to the body of these K-type 2-seaters and two more models were added to the range, a 4-seater Tourer and a Drophead Coupe, all being fitted with the same engine. With more ALLARD cars competing in all types of events an increase in the number of victories naturally followed, and no less than 11 trophies were collected in international events alone that year, including four in the Alpine Trial.

In response to public demand a Saloon model was introduced in 1949 and although the necessarily heavier weight of a closed body made it less suitable for competition motoring than its open predecessors, the model was an immediate success. Business and professional men, a very large proportion of them being doctors, saw in it a car of distinctive but not bizarre appearance, possessing the power to move easily in slow moving traffic until such time as its vivid acceleration and high cruising speed could be brought into use solely by depressing the pedal. This year saw the number of international trophies won double that of 1948, with 3 in the Monte Carlo

J.2 COMPETITION  
2-SEATER CHASSIS  
WITH O.H.V. ENGINE

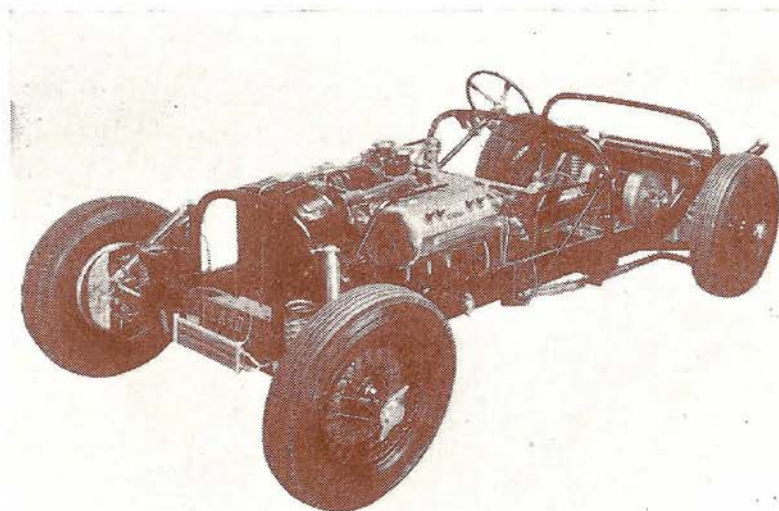

. . . . of the **ALLARD**

## *A History . . . continued*

Rally, 6 in the Lisbon Rally, 5 in the Alpine Rally and successes in seven other international events consisting of hill-climbs, rallies and speed trials.

Although introduced during the previous year it was not until 1950 that the J.2 Competition 2-seater began arriving in foreign markets. A short chassis lightweight 2-seater, designed primarily for competition motoring, such has been the demand for this model from sporting motorists overseas that only a mere handful have reached the home market. The racing motorists in U.S.A. soon found that with a Cadillac engine fitted in this model there was nothing in its class to hold it, and success followed success. Many types of V.8 engines have been fitted by various owners in the States, or by our works to customers' requirements, and all have proved victorious in important events overseas.

No fewer than 45 successes were achieved by ALLARD J.2's during the first year in Switzerland, France, U.S.A., Portugal and Denmark as well as in the British Isles, and several other countries have witnessed victories by this model already this year.

Another newcomer to the marque is the K.2 Sports 2-seater, first produced in 1950, and this model has proved just as popular abroad as the J.2, with consequent 'starvation' of home demands. With high-compression heads and dual induction fitted to the standard engine, a really high performance can be obtained despite the full-size wings, full-width windscreen, etc., of this sports roadster.

19 international successes came the way of ALLARD cars during 1950.

THE ALLARD MOTOR COMPANY has certainly come a long way in four years.

\* \* \* \* \*

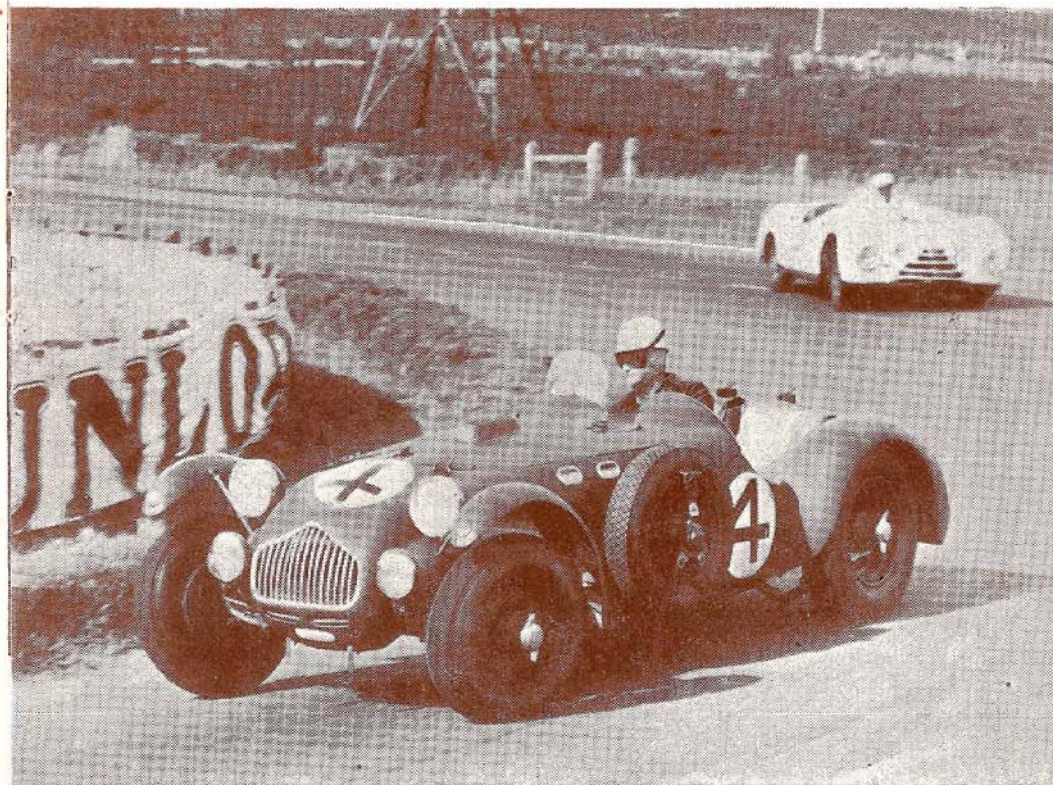

### LE MANS 24-HOUR RACE, JUNE 1950

TOM COLE OF NEW YORK BRINGING HOME SYDNEY ALLARD'S CADILLAC ENGINED ALLARD J.2 INTO THIRD PLACE IN THE GRUELLING LE MANS ENDURANCE RACE IN FRANCE. TOM AND SYDNEY RAN THE CAR 2118 MILES IN THE 24 HOURS AT AN OVERALL AVERAGE OF 82.2 M.P.H. TO BREAK THE CLASS DISTANCE RECORD, WIN ITS CLASS AND BE FIRST BRITISH CAR IN THE EVENT.



---

## THE ALLARD POLICY . . . .

---

BY SYDNEY H. ALLARD, A.M.I.A.E., M.I.M.T.

*The aims of the Allard Motor Company are, as they have always been, to produce high-performance cars and to sell them at the lowest possible price consistent with limited and specialised production.*

*As a private company and a 'family concern,' we have no necessity to constantly aim at increased turnover and profits in order to satisfy shareholders whose natural interest is in dividends rather than in motor-cars.*

*Every Allard car is 'tailored,' the chassis individually assembled and the body built on to the chassis by hand. When the car is complete the body is dismantled for its journey through the paint shop and again assembled.*

*It is inevitable that the problem of performance or roominess should arise whenever a new four-seater model is designed, but we have hitherto decided to maintain our original intention to concentrate on performance—not a record top speed but a high average over long distances and the most efficient of road-holding. When we have evolved a satisfactory method of increasing body capacity without impairing either speed or manoeuvrability we shall not hesitate to combine these virtues.*

*Meanwhile, we shall continue to offer cars for which we claim a high all-round performance with complete safety, distinctive appearance and world-wide service, and a model to suit every taste from the out-and-out competition motorist to the business man who wishes to travel far, fast and safely.*

\* \* \*

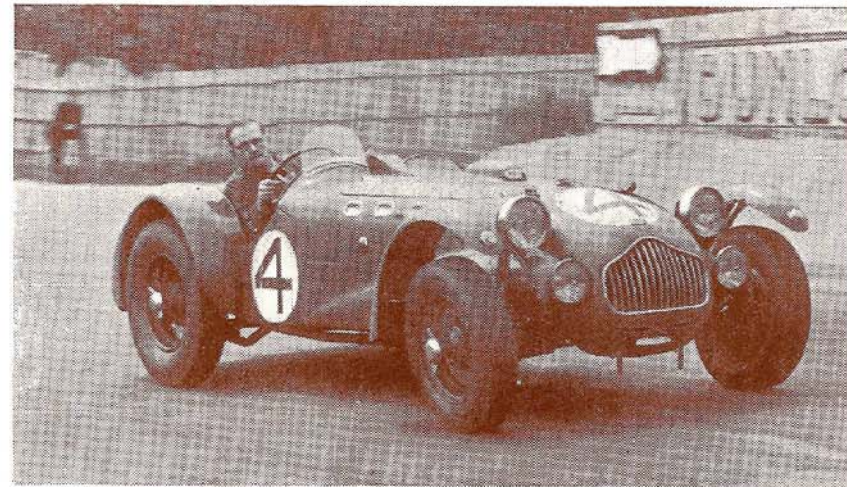

● SYDNEY H. ALLARD—LE MANS, 1950

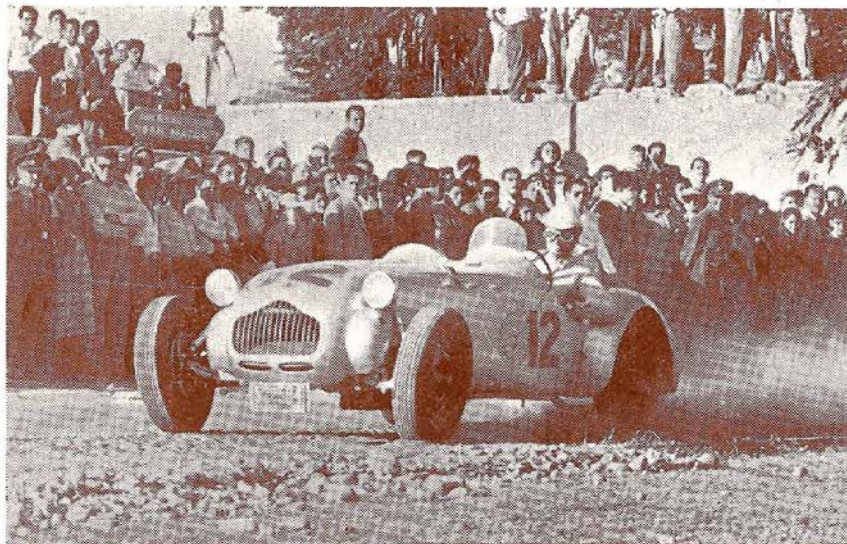

● EDUARDO DIBOS,—PERU, 1951

# INTERNATIONAL SUCCESSES

## 1947

LISBON RALLY : 1st of 173 competitors.

ALPINE TRIAL : Winner of Coupe de Aix-les-Bains.

MALOJA HILL-CLIMB : 1st in Sports Car Class (Course Record).

DEVELIER DES RANGIERES : 1st in Unlimited Sports Car Class.

CRAIGANTLET HILL-CLIMB : 1st in Racing Car Classes.

BOULEY BAY HILL-CLIMB : 1st in Sports Car Classes.

## 1948

MONT VENTOUX HILL-CLIMB : 1st in Sports Car Class.

VUE DES ALPES HILL-CLIMB : 1st in Unlimited Sports Car Class.

RHEINECK-WALZENHAUSEN-LACHEN : 1st in Unlimited Sports Car Class.

ALPINE TRIAL : Winner of Coupe des Alpes ; Winner of Coupe de Paris-Pressé ; Winner of Coupe de Mont Ventoux ; Winner of Commissariat General de Tourisme Medallion.

SHELSEY WALSH HILL-CLIMB : Fastest Unsupercharged Car (Course Record).

PRESCOTT HILL-CLIMB : Fastest Unsupercharged Car.

BOULEY BAY HILL-CLIMB : Fastest Unsupercharged Car.

CRAIGANTLET HILL-CLIMB : Fastest Unsupercharged Car.

## 1949

MONTE CARLO RALLY : Winners of Team Challenge Trophy ; Winner of Stuart Trophy ; Winner of Late Public Schools Cup.

LISBON RALLY : 1st of 111 competitors. Winner of five trophies.

BONESS HILL-CLIMB : Fastest Sports Car (Course Record).

ALPINE RALLY : Five 1sts.

## 1949 *(continued)*

BOULEY BAY HILL-CLIMB : Fastest Time of the Day, 1st in Racing Car Class.

DEVELIERS DES RANGIERES : 1st in Experts Class (Class Record).

MONT VENTOUX HILL-CLIMB : 1st in Unsupercharged Class ; 1st in Sports Car Class.

MALOJA HILL-CLIMB : 1st in Experts Class.

BRIGHTON SPEED TRIALS : Winner of Chater Lea Trophy.

PRESCOTT : Fastest Time of the Day (Course Record) ; 1st in Sports Car Class ; 1st in Racing Car Class ; Team Award.

## 1950

MONTE CARLO RALLY : Won Stuart Trophy ; Won B.T.D.A. Cup.

RALLY SOLEIL CANNES : 1st in General Classification.

CIRCUIT OF IRELAND : 1st of 167 competitors ; 1st in Sports Car Class ; Winner of Castlereagh Trophy.

CRAIGANTLET HILL-CLIMB : Fastest Time of the Day ; 1st in Racing Car Classes.

VUE DES ALPES : Fastest Unsupercharged Sports Car ; Won Ladies Cup.

SIERRE-MONTANA-CRANS : 1st in Touring Car Class (Amateur).

LE MANS : 1st in Class (Course Record).

SUSE-MONT CENIS : Winner of Suse Cup.

WATKINS GLEN GRAND PRIX : 1st in General Classification (Record Average).

REST-AND-BE-THANKFUL : Won Frew Cup ; 1st in Class.

LEINSTER TROPHY RACE : Fastest Standing Lap.

PRESCOTT HILL-CLIMB : 1st in Sports Car Class.

BRIGHTON SPEED TRIALS : Fastest Sports Car (Course Record).

ALLARD

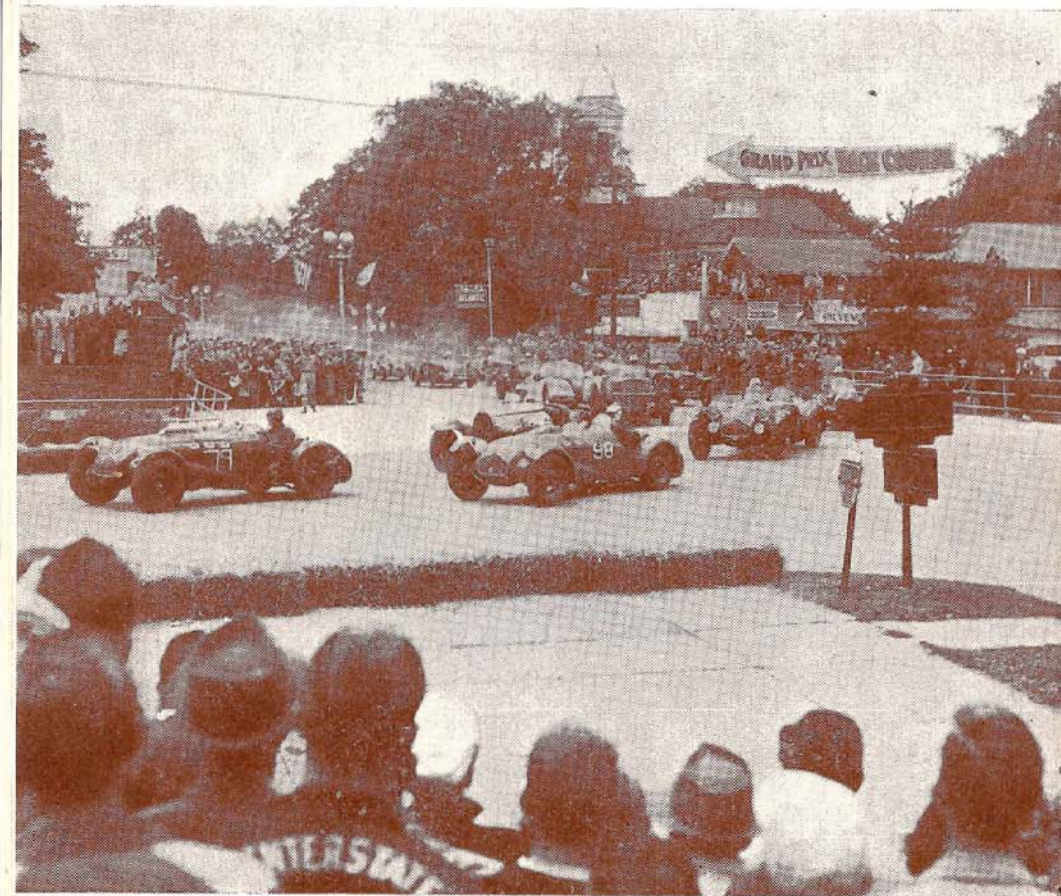

WATKINS GLEN GRAND PRIX - U.S.A. 1950

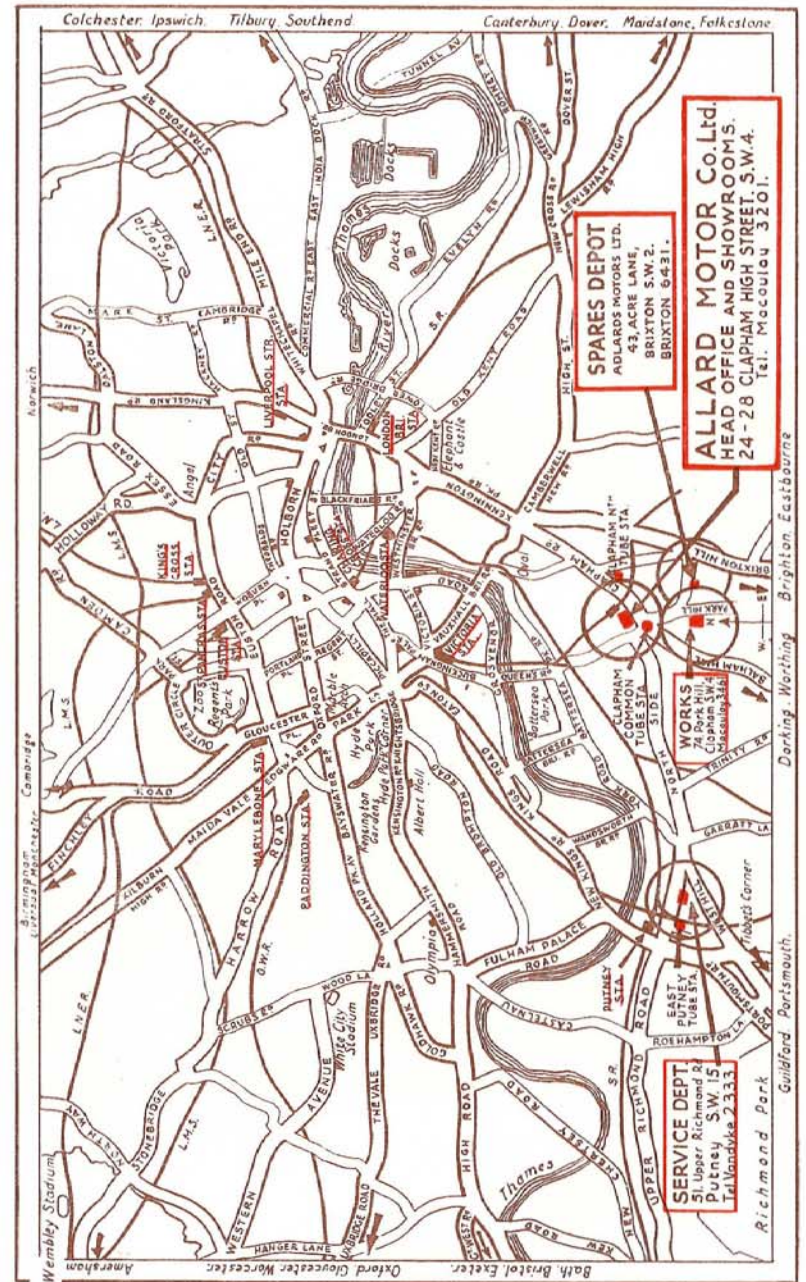

CURRENT MODELS . . . . .

The ALLARD Saloon, with aluminium-panelled coachbuilt body, incorporates all the good features of the previous models, including sports-car manners on the road, plus such refinements as independently-adjustable close-fitting front seats allowing ample room for 3 abreast, luxurious hide upholstery with latex cushion rubber, controlled air conditioning, interior lighting with door-operated switch, and, for overseas models only at present, heating equipment.

Other good points are an opening windscreen for safe driving in fog and comfort in heat, and a very spacious lockable luggage boot with interior lighting.

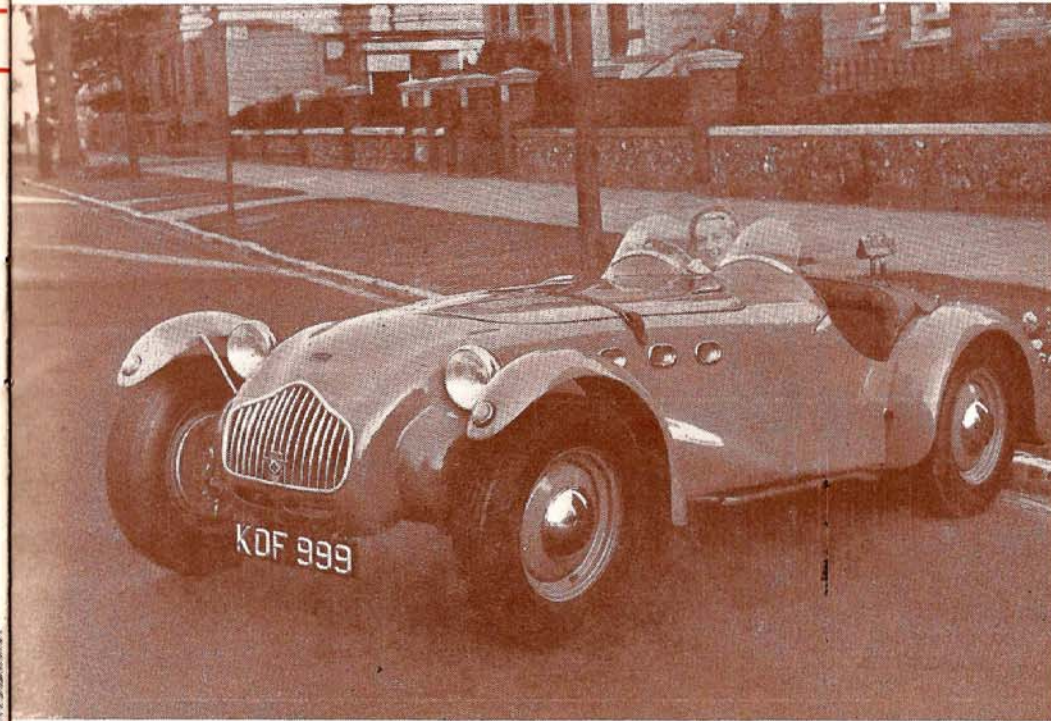
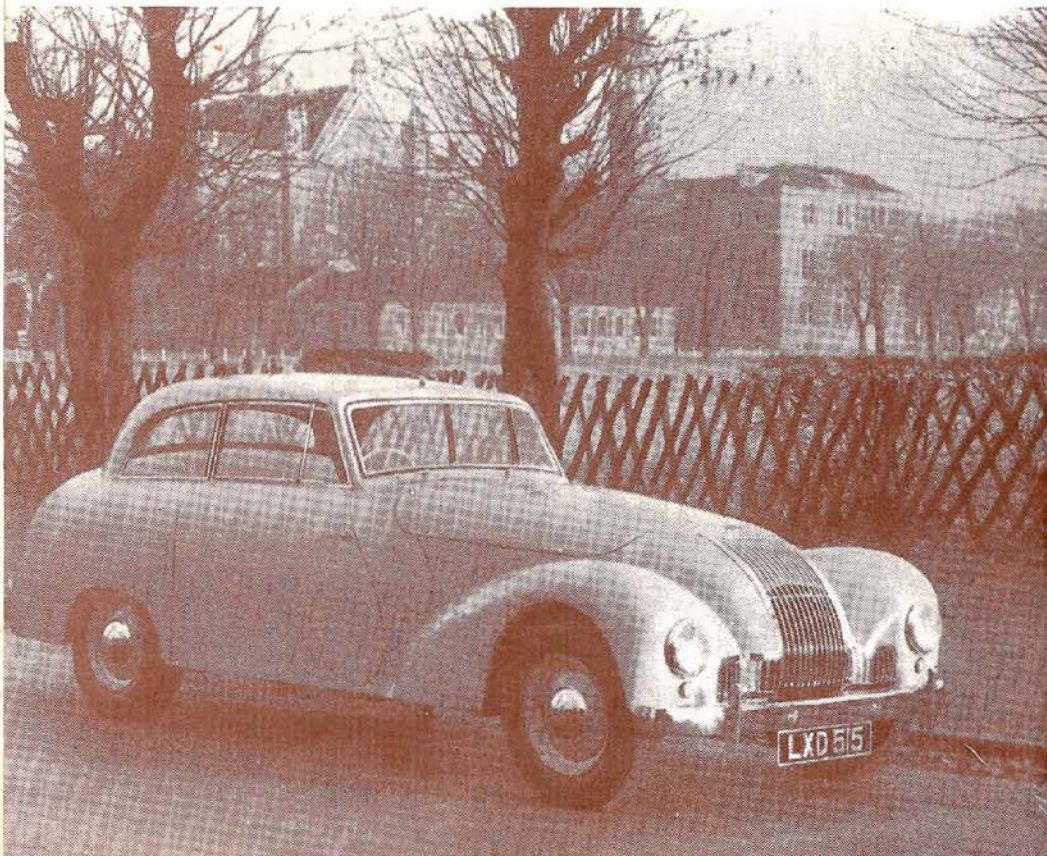

Built mainly for participation in sporting events, the J.2 Competition 2-seater is undoubtedly destined to create many sensations in that field and to add to the long list of successes achieved by previous ALLARD models.

For the benefit of sporting enthusiasts overseas, the chassis is specially designed to accommodate many of the larger capacity American engines, and the car can be supplied less engine if preferred

With its aluminium body the dry weight of the complete car is only 2006lb.

The K.2 Sports 2-seater has been designed for the motorist who prefers a touring car which is capable of putting up a good sports performance.

It has high-compression cylinder heads, dual induction with twin Solex carburettors, remote centre gear change and racing-type fly-off handbrake. Like the J.2, the chassis has been designed to accommodate alternative engines if required.

The body is aluminium-panelled and has a large lockable luggage boot and all-weather equipment.

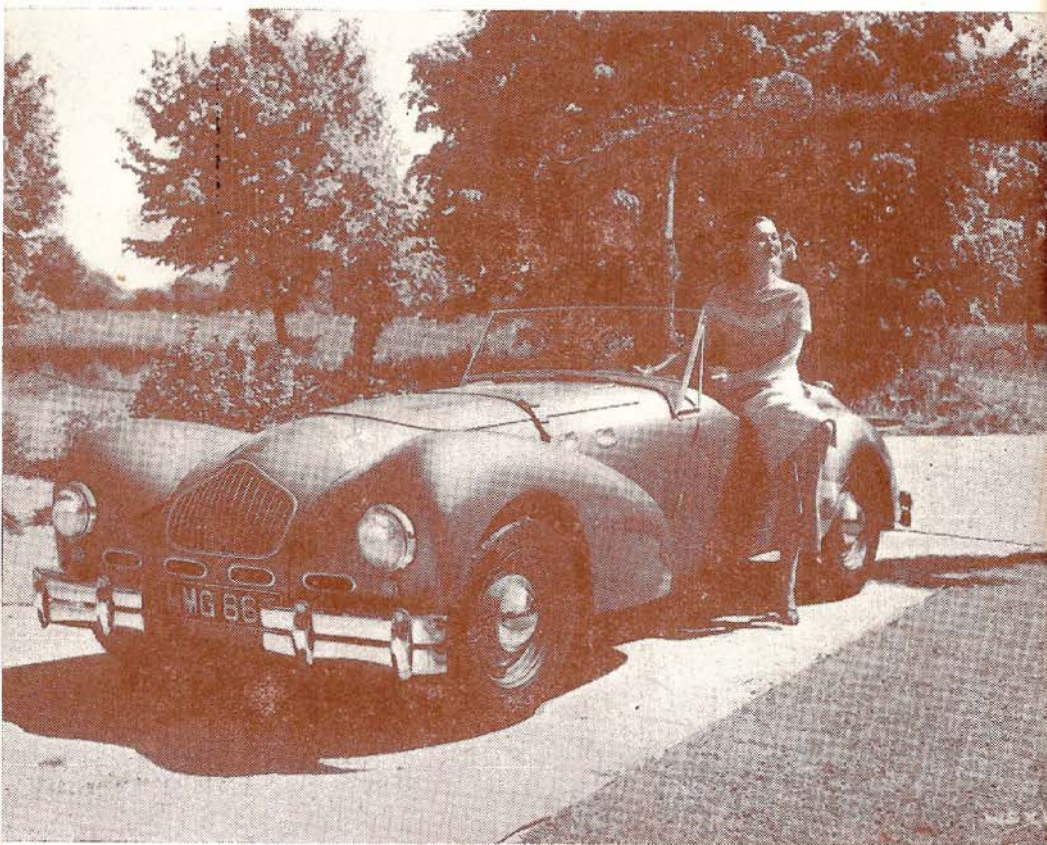

..... CURRENT MODELS



" THE ALLARD OWNERS' CLUB is open to all Allard enthusiasts and aims to promote and encourage social and competitive meetings between members and to disseminate technical information."

This extract from the rules of the A.O.C. would really suffice to tell you about the Club, but perhaps just a little elaboration would be of interest.

Recently formed, with temporary headquarters at the Head Office of the Allard Motor Company by whom it is sponsored, the Allard Owners' Club is rapidly expanding both in membership and in the scope of its activities and it should be possible in the near future to open district branches to make local arrangements.

The Club offers the sporting motorist, whether novice or seasoned 'veteran' first hand information and advice from fellow members with long experience in every type of competition motoring rallies, hill-climbs, speed events, trials, scrambles and gymkhanas and having actual experience in every event of any importance.

For the Allard enthusiast who is not competition minded the A.O.C. offers many social amenities such as air trips to important continental events, a private tent at the main British Meetings, an annual dinner, a gymkhana (good fun this) and an occasional "noggin and natter."

Another privilege enjoyed by members of the Club is a free subscription to the Enthusiasts' Edition of the Allard News Letter, a bi-monthly bulletin giving all the Allard news.

Full particulars about the Allard Owners' Club can be obtained from the Hon. Secretary at 24 Clapham High Street, London, S.W.4.



# Celebrities

are many among Allard enthusiasts  
They include stars of the Continental  
rallies . . . . .

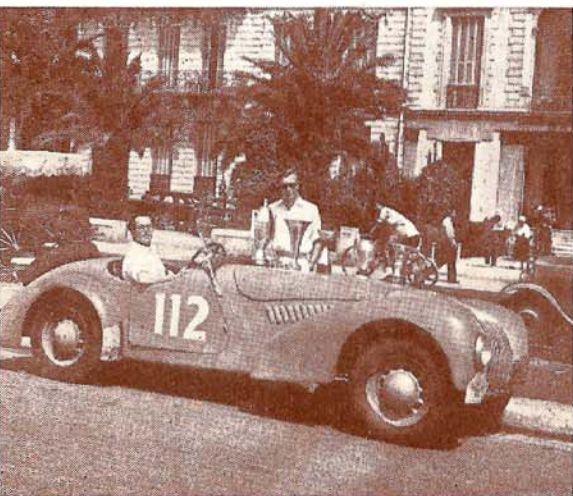

LEN POTTER

. . . . . the racing circuits

GUISEPPE FARINA

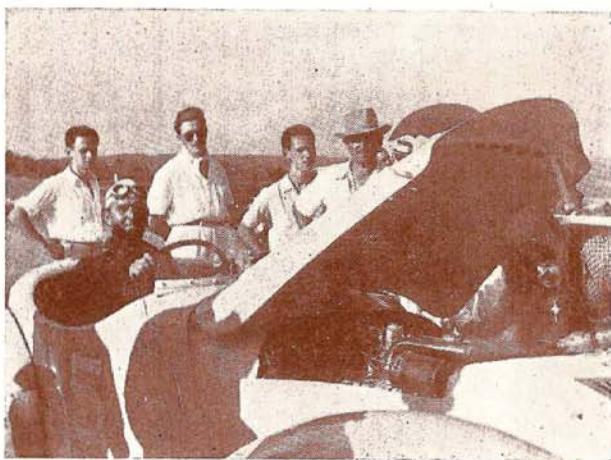

the Screen . . . . .



JEAN KENT

. . . . . and Radio

RICHARD DIMBLEBY



## AN EARLY ALLARD

1939 2/4 seater, the first Allard to approximate to a production model

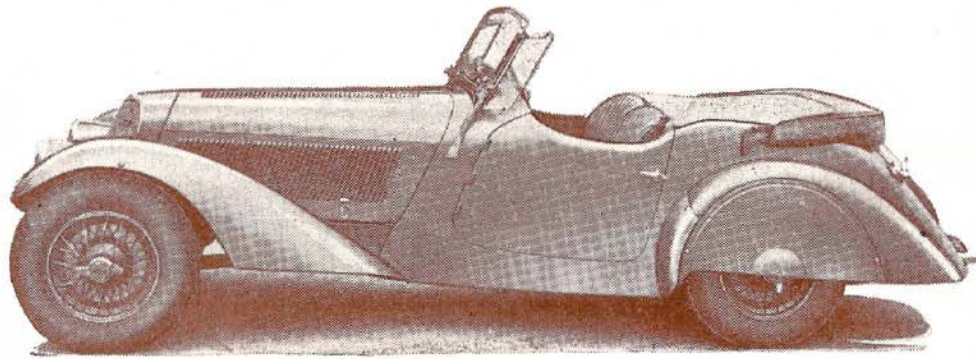

### *Facts about some Allard Distributors and Suppliers*

#### **ALEXANDERS OF EDINBURGH**

FOUNDED BY THE late James Robert Alexander in 1869. Into the business were poured all the ideas and enthusiasm of this pioneer and Grand Old Man of Cycling and on all counts he was ably assisted by his three sons, James, Henry and Alfred, the present Directors.

James and Alfred earned for themselves a permanent place in the history of cycle and motor cycle championships, while Henry, in 1911, achieved the impossible by driving a Model T Ford to the summit of Ben Nevis and down again. The sons also made successful short flights in 1910 in an aeroplane manufactured by the firm. The success of the whole family in the field of practical endeavour gained for them an experience of lasting importance, for it is this experience which has been used so wisely to promote Alexanders to a highly specialised organisation embracing the most modern cycle, motor cycle and automobile development. This organisation can claim to have put more people on wheels than any other firm in Scotland.

Today, Alexanders is still controlled by the founder's three sons, and the prospects of maintaining the finest service of its kind in Scotland are looked forward to with confidence and pleasure. \* \* \*

#### **H. E. NUNN & CO. LTD.**

H. E. NUNN & Co. LTD., 282 Bury New Road, Manchester 7, have been Allard distributors for Lancashire and Cheshire right from the start, and are one of the largest distributors in the provinces.

Well equipped with spacious showrooms, extensive service works, body repair and paint shop, they have an organisation second to none and are in a position to give quick and efficient service to all Allard owners at all times. \* \* \*

#### **R. H. PATTERSON & CO. LTD.**

MESSRS. R. H. PATTERSON & Co. LTD., was founded in 1911 as Colliery and General Engineers, and their entry into the Motor Trade took place in 1918 when they became dealers in various makes of Motor Cars. In 1926 they discarded their General Engineering and took a Main Dealership with Ford Motor Company Limited. They are now one of the best known Ford Dealers in England, and have an extensive interest, not only in cars and trucks, but in Fordson Tractors and Agricultural Implements. Also a Tyre Department which is stocked with a wide range of tyres for all types of vehicles.

Their connection with Allards started in 1946 when they were appointed Main Dealers for the counties of Northumberland, Durham, Cumberland and Westmorland. This was originally a side line but they soon built up a well merited reputation with a very efficient Repair and Service Department. In fact, since their inception 'Service' has been their motto, as they believe that once a sale is made it is only the beginning of the transaction and their duty is to see that the customer continues to be completely satisfied with his motor car, their mechanics being specially trained for this purpose. \* \* \*

#### **LOCKHEED BRAKES ON ALLARD CARS**

THE TWO-LEADING shoe Lockheed hydraulic brakes fitted to Allard models are specially designed to give smooth, efficient braking under all conditions, on the world's fastest production cars.

Lockheed hydraulic brakes are not only synonymous with speed, but also with service, since under the Lockheed Hydraulic Brake Shoe Replacement System, factory relined shoes can be obtained at a moment's notice from any service station and apart from a simple adjustment no further maintenance is required, other than topping up the supply tank with the Genuine Lockheed Hydraulic Fluid at long intervals. \* \* \*

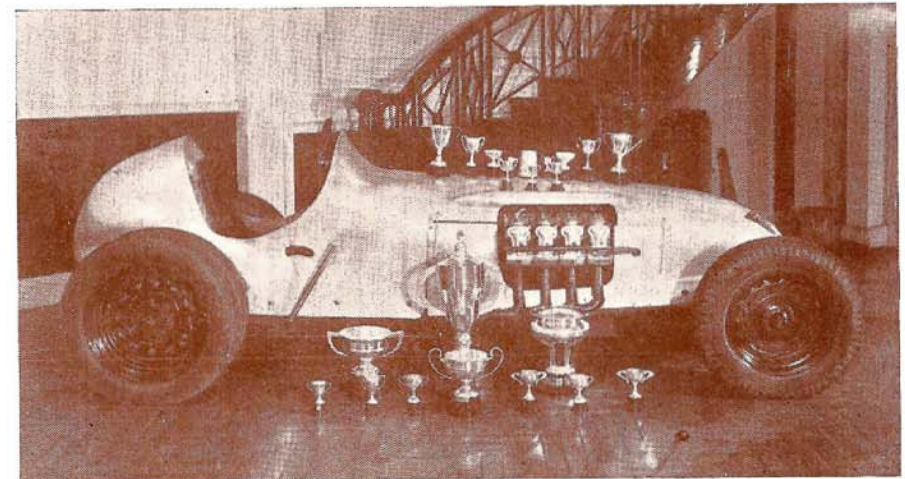

A WINNING ALLARD

Mr. Sydney Allard's Steyr-Allard

### *The ALLARD Radiator*

is produced to the designer's instructions by the acknowledged leaders in the sphere of cooling, backed by a nation-wide specialist service in radiator maintenance and repair to the motor trade.

### **SERCK RADIATORS LIMITED**

Park Royal Road, North Acton, London, NW10

Head Office: Birmingham. Branch Factories throughout the British Isles

## **NEWTON**

### **HOLDING COMPONENTS**

We are suppliers of Precision Holding Components to the British Electrical, Aircraft and Motor Industries and are equipped to give exceptional service in mass quantity repetition work of high uniform quality.

An experimental department is at your disposal for special requirements

**BOLTS, NUTS, SCREWS, RIVETS, SMALL PRESSINGS,  
FORMED WIRE WORK, SCREW MACHINE PRODUCTS,  
REPETITION WORK**

**L. H. NEWTON & CO. LTD.** Nechells, Birmingham, 7  
Incorporating H. Tonks & Co.  
Telephone : EASt 1551 (16 lines)

London . Coventry . Manchester . Bristol . Dublin . South Africa . New Zealand  
India . South America . Denmark . Norway . Holland . Ceylon and all M.E. Countries



### **SALES and SERVICE**

Distributors for S.W.Scotland

## **GEORGE & JOBLING**

140/160 Bothwell Street

**GLASGOW, C.2.**

Telephone  
Glasgow Central  
6251/2/3

### *For ALLARDS in —* **YORKSHIRE**

- Quick and Efficient Repair Service
- Finest Car Valeting Station in the North
- Garage for over 2,000 cars

**(Guaranteed Used Cars in Stock)**

DISTRIBUTORS FOR YORKSHIRE

## **TATE of LEEDS** LTD.

New York Road, Leeds

Tel. 31281



## Paramount Sheet Metal Works (London) Ltd.

Manufacturers of

**WINGS,  
RADIATOR GRILLES, etc. for  
THE ALLARD MOTOR CO. LTD.**

PANEL-BEATING, PROTO-TYPE AND ALL  
GENERAL SHEET METAL WORK

77 KINGS ROAD, S.W.3

FLA. 2487

## BRITISH & COLONIAL MOTORS LTD.

We specialise in low mileage cars  
of all the leading makes including  
late models of the Allard range

SHOWROOMS:

77 ST. MARTIN'S LANE, LONDON, W.C.2

Telephone : **TEMPLE BAR 3588**



**DISTRIBUTORS**

for

**DERBYSHIRE, NOTTINGHAMSHIRE  
LINCOLNSHIRE, LEICESTERSHIRE  
and RUTLAND**

**UNIVERSAL CAR CO. (DERBY) LTD.**

ST. HELENS' STREET, DERBY

TELEPHONE 2247 DERBY (3 lines)

Telegrams: "Unicar, Derby."

## ALEXANDERS OF EDINBURGH LTD.

COACH BUILDERS · MOTOR ENGINEERS

**ALLARD DISTRIBUTORS  
FOR S.E. SCOTLAND**

CONTRACTORS TO H.M. GOVERNMENT

Phones

25131 - 7 lines

Showroom

80 LOTHIAN ROAD

**SEMPLE STREET · EDINBURGH**

for Town or Country . . .

## ALLARD SPORTS CARS

★

you'll do **A GOOD DEAL** better with

THE MAIN DISTRIBUTORS

### ARTHUR E. GOULD LTD.

290/292 REGENT STREET, W.1.

for **ALL ALLARD MODELS**

Tel. LANGHAM 1594/5

---

## ALLARD BODY REPAIRS

BODY FITTINGS  
FOR ALL MODELS  
IN STOCK

**ENCON COACHWORKS**  
MAKERS OF ALLARD J.2 AND K.2 BODIES

9 ESTCOURT ROAD  
FULHAM  
LONDON  
S.W.6

Phone: Fulham 4021

Page Thirty-two

## FOR GOOD DRIVERS: Two Safety Rules

1

### HAVE BRAKES TESTED REGULARLY

Even the best brakes wear down with use, and lose some of their efficiency. But the change is so gradual that it may not be noticed. For safety, brakes should be checked *regularly*, as a matter of routine. A good reminder is: "Test your brakes when you change your oil—every 2,000 3,000 miles."

2

### FIT THE LININGS THAT MUST BE RIGHT

When brakes need relining, take no chances. Fit the linings chosen by Allard for their competition cars, which have achieved outstanding successes in sporting events, and by the makers of most British cars and heavy vehicles.

# FERODO

## Brake Linings

*Standard on most British vehicles—supplied in  
correct grades for EVERY make in the world*

FERODO LIMITED  
CHAPEL-EN-LE-FRITH

A Member of the  
Turner & Newall Organization